

# John Wayne Airport Activity Book

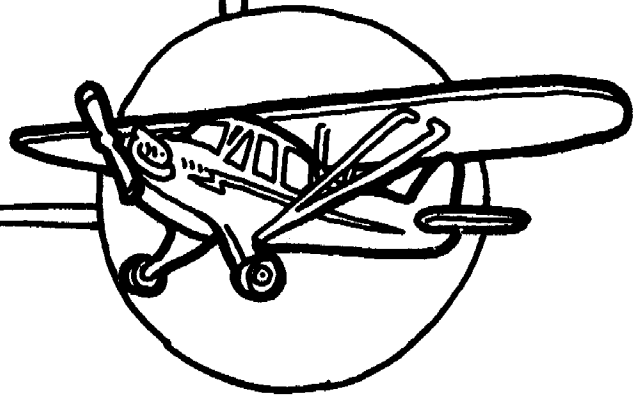
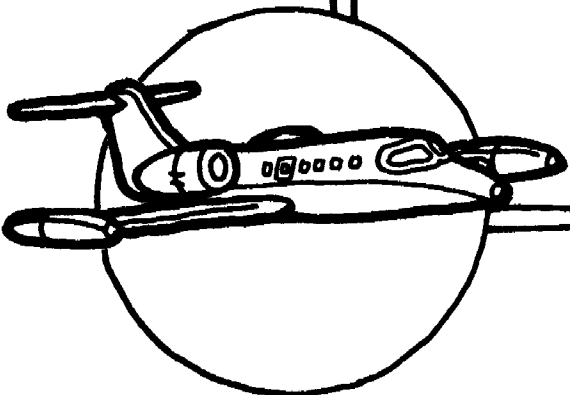
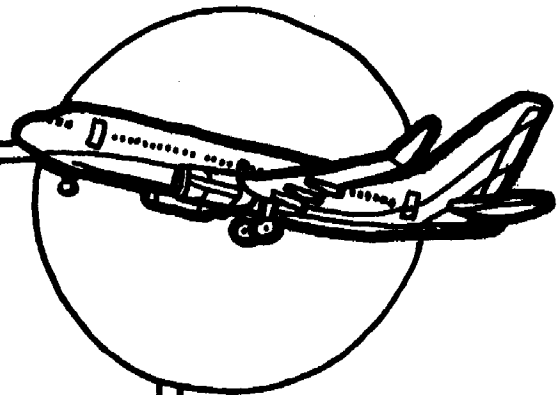
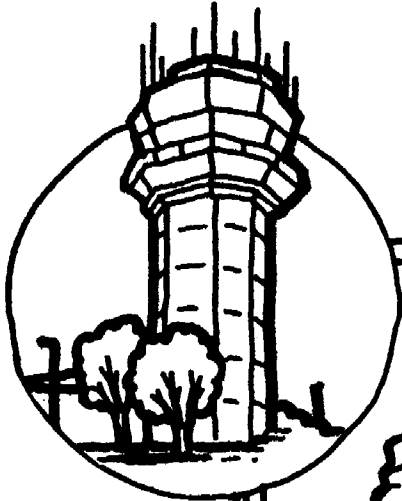
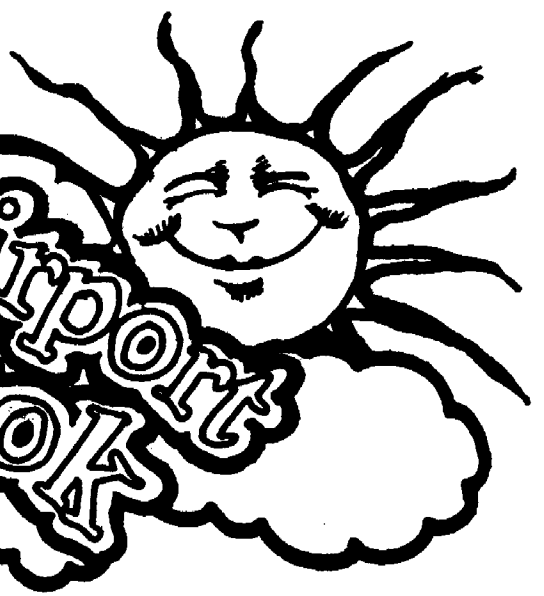

# This Activity Book Belongs To:

---

**My Favorite Color is:** \_\_\_\_\_

**My Favorite Food is:** \_\_\_\_\_

**My Favorite Sport is:** \_\_\_\_\_

**My Favorite City is:** \_\_\_\_\_



## Welcome to John Wayne Airport!

Our airport is a very busy and interesting place. You'll see a lot of folks here who are traveling on vacation and for work, but if you look closely, maybe you can find some of the people who *work* here too. Can you spot a pilot who flies an airplane, or a "sky cap" who helps passengers with their luggage, or even one of our deputies with his four-legged partner (a dog - woof!) who helps keep our visitors safe?

This Activity Book was made just for you. We hope that it teaches you a little about our airport - like what kind of airplanes fly here - and especially about the people who make John Wayne Airport a safe and special place. Inside this book you'll find a maze, a word search, great pictures to color, and even an invitation to have your own artwork posted on JWA's Web site!

We hope you enjoy this book - and your visit to John Wayne Airport. Come back and see us soon!

Alan L. Murphy  
Airport Director



START

ARRIVE AT  
AIRPORT

ACROSS THE  
STREET FROM  
THE AIRPORT  
START  
OVER

GET A  
SNACK



PARK YOUR  
CAR



WALK TO  
TERMINAL



GO THROUGH  
SECURITY



CHECK YOUR  
LUGGAGE



WALK TO  
YOUR GATE



LOOK AT  
ART EXHIBIT



WAIT FOR  
YOUR  
FLIGHT



BOARD YOUR FLIGHT

AIRPORT MAZE





\_\_\_ATLANTA \_\_\_CHICAGO \_\_\_CINCINNATI/NORTH KENTUCKY \_\_\_DALLAS/FORTH WORTH \_\_\_DENVER \_\_\_HOUSTON \_\_\_LAS VEGAS  
 \_\_\_MINNEAPOLIS/ST.PAUL \_\_\_NEWARK \_\_\_OAKLAND \_\_\_PHOENIX \_\_\_PORTLAND \_\_\_SACRAMENTO \_\_\_SALT LAKE CITY  
 \_\_\_SAN FRANCISCO \_\_\_SAN JOSE \_\_\_SEATTLE

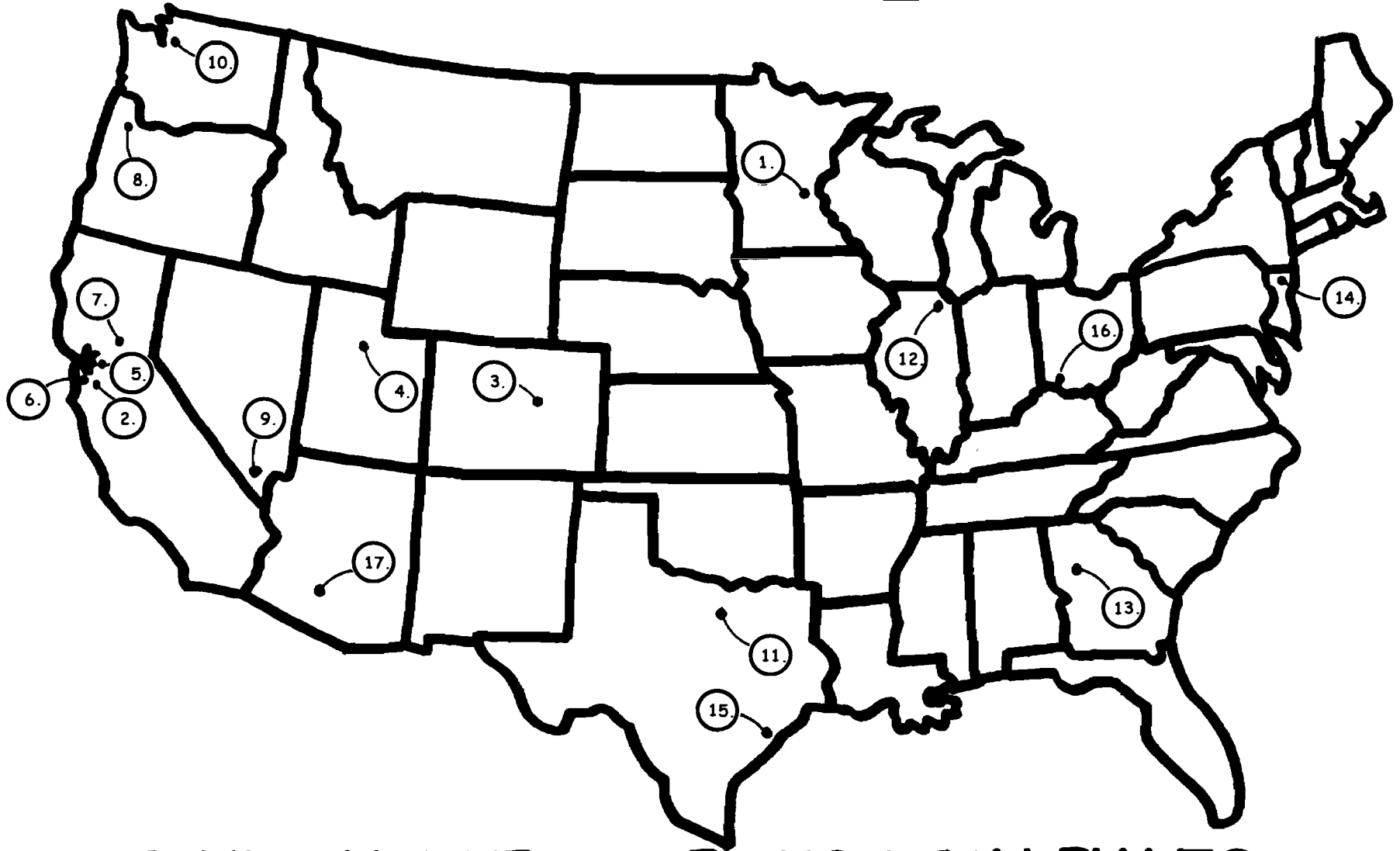

**FIND ALL THE CITIES YOU CAN FLY TO  
NON-STOP FROM JOHN WAYNE AIRPORT**

1. MINNEAPOLIS/ST. PAUL; 2. SAN JOSE; 3. DENVER; 4. SALT LAKE CITY; 5. OAKLAND; 6. SAN FRANCISCO; 7. SACRAMENTO; 8. PORTLAND; 9. LAS VEGAS;  
 10. SEATTLE; 11. NEWARK; 12. DALLAS/FORTH WORTH; 13. ATLANTA; 14. CINCINNATI/NORTH KENTUCKY; 15. HOUSTON; 16. PHOENIX; 17. PHOENIX

*The Vi Smith Concourse Gallery*

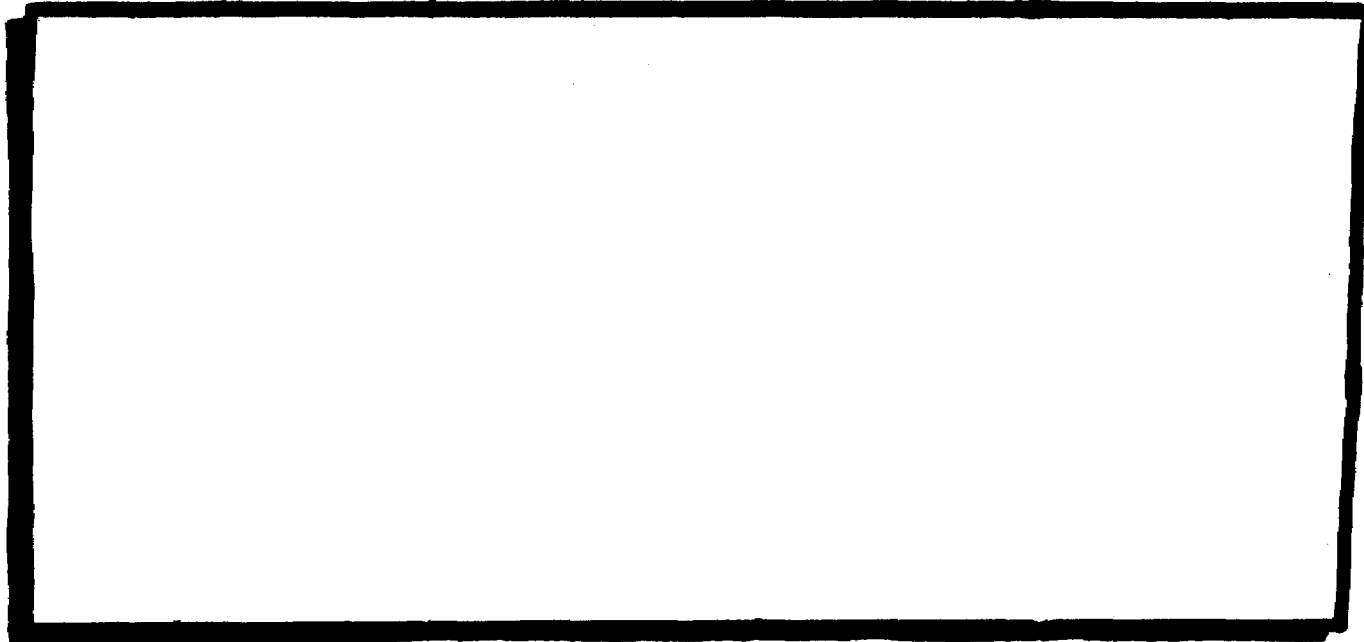

**DRAW YOUR OWN AIRPORT MASTERPIECE**



**AIRBUS A320**

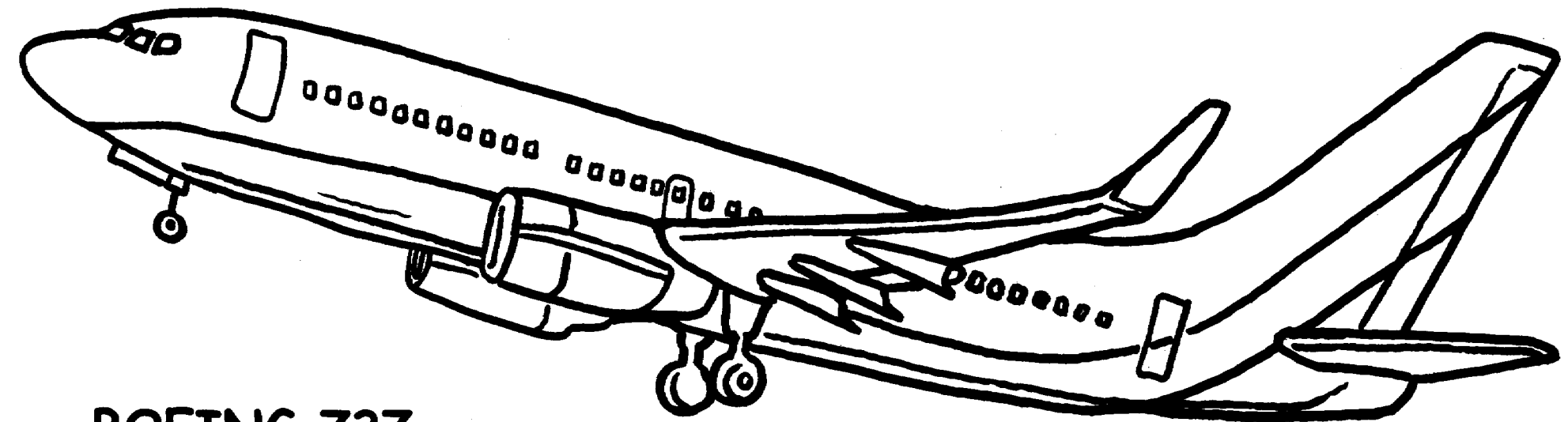

**BOEING 737**

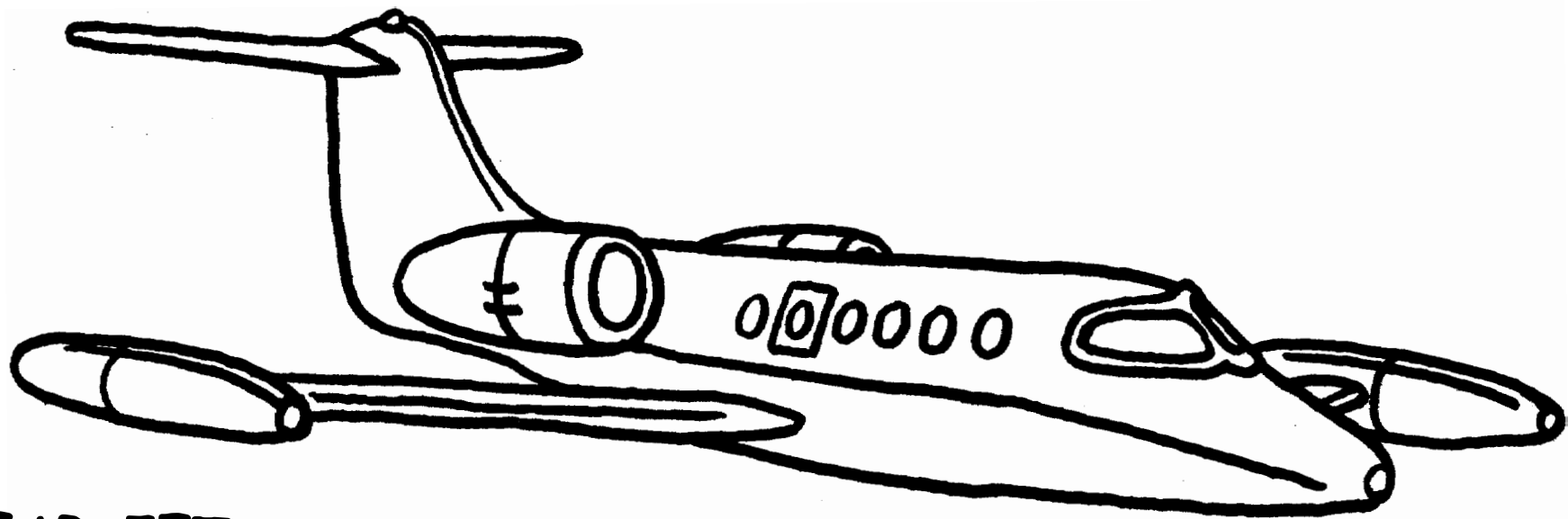

LEAR JET

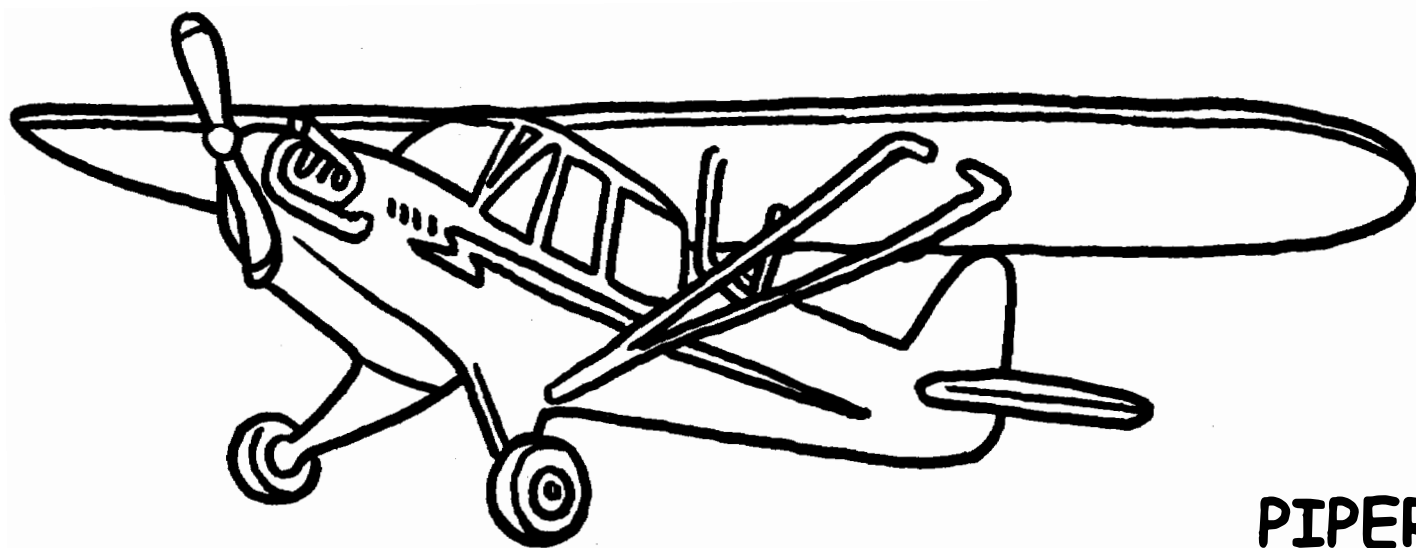

PIPER CUB



**AIRPORT POLICE SERVICES**  
**ORANGE COUNTY SHERIFF'S DEPARTMENT**

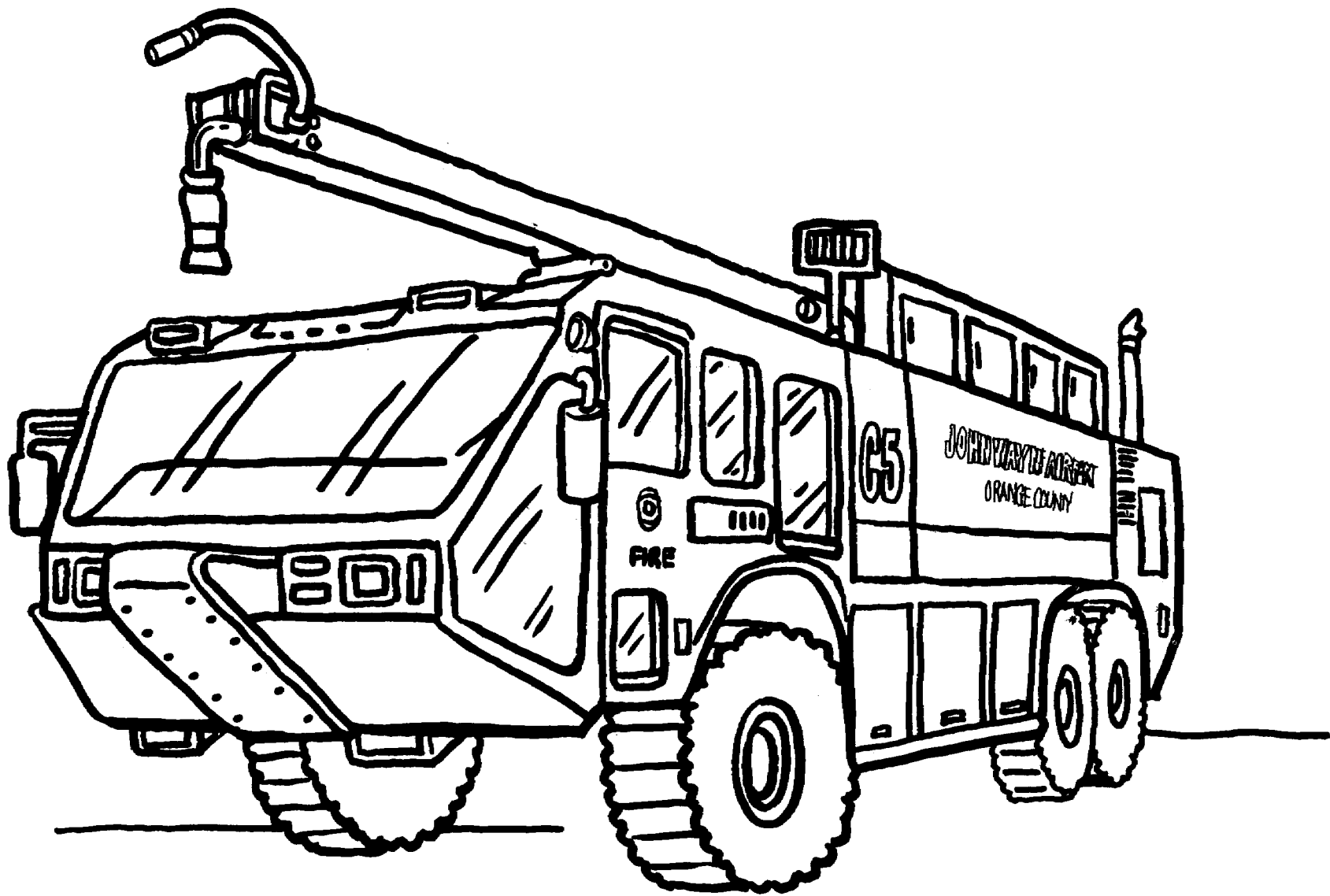

**AIRCRAFT RESCUE AND FIREFIGHTING SERVICES**  
**ORANGE COUNTY FIRE AUTHORITY**

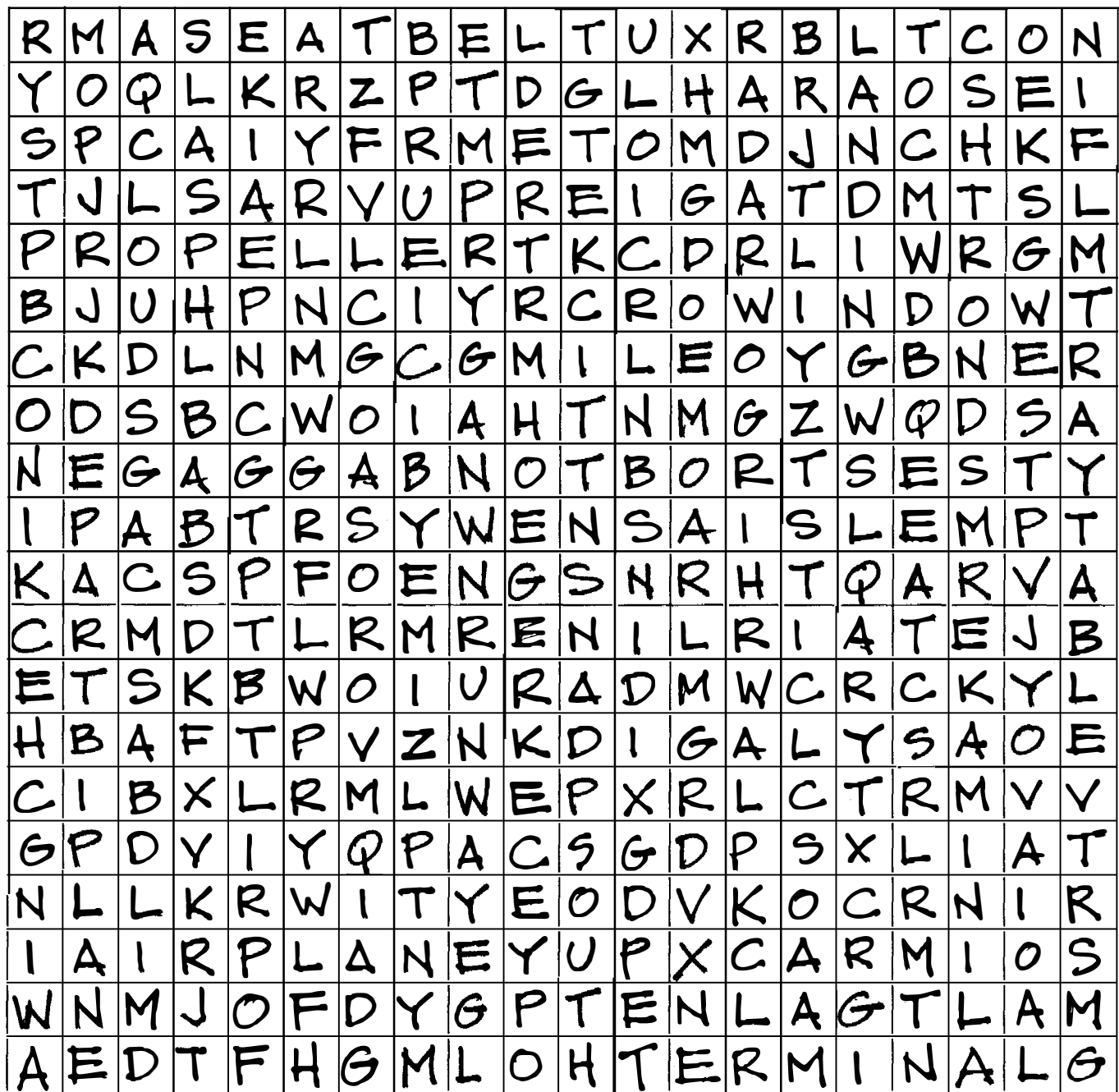

**-WORD SEARCH-**

**FIND ALL THESE WORDS HIDDEN IN THIS LETTER GRID**

AIRPLANE

AISLE

ARRIVE

BAGGAGE

BIPLANE

CARGO

CHECK IN

CLOUDS

CONTROL TOWER

DEPART

EAST

ENGINE

FLYING

JET AIRLINER

JOHN WAYNE AIRPORT

LANDING

LIGHTS

NORTH

PILOT

PROPELLER

RADAR

RUNWAY

SKY

SOUTH

TAIL

TAXIWAY

TERMINAL

TICKET

TRAY TABLE

VACATION

WEST

WINDOW

WING

# WHAT IS IT?

CONNECT THE DOTS  
TO FIND OUT!

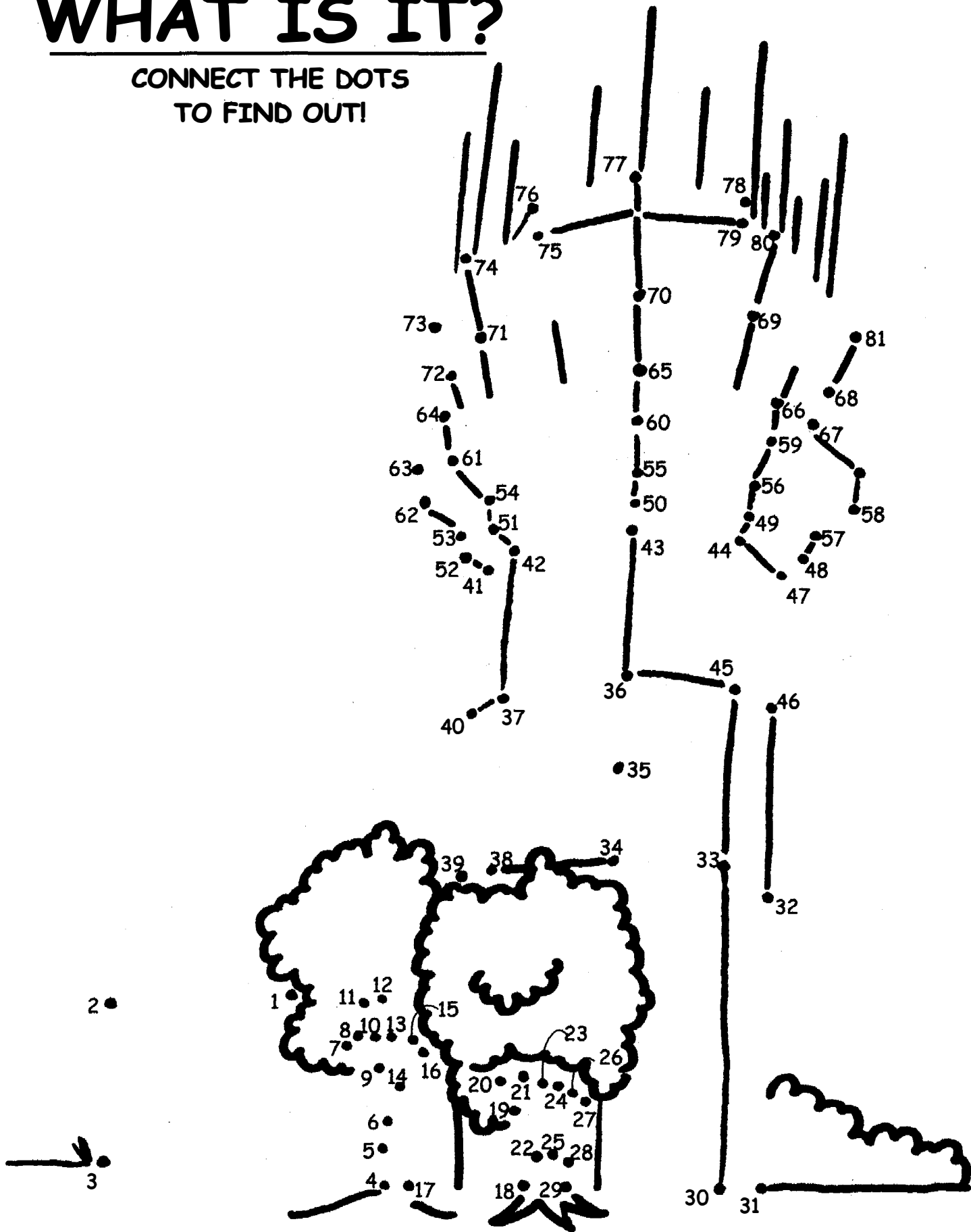

# NAME THESE AIRPLANE PARTS

1. \_\_\_\_\_
2. \_\_\_\_\_
3. \_\_\_\_\_
4. \_\_\_\_\_
5. \_\_\_\_\_
6. \_\_\_\_\_
7. \_\_\_\_\_
8. \_\_\_\_\_
9. \_\_\_\_\_
10. \_\_\_\_\_

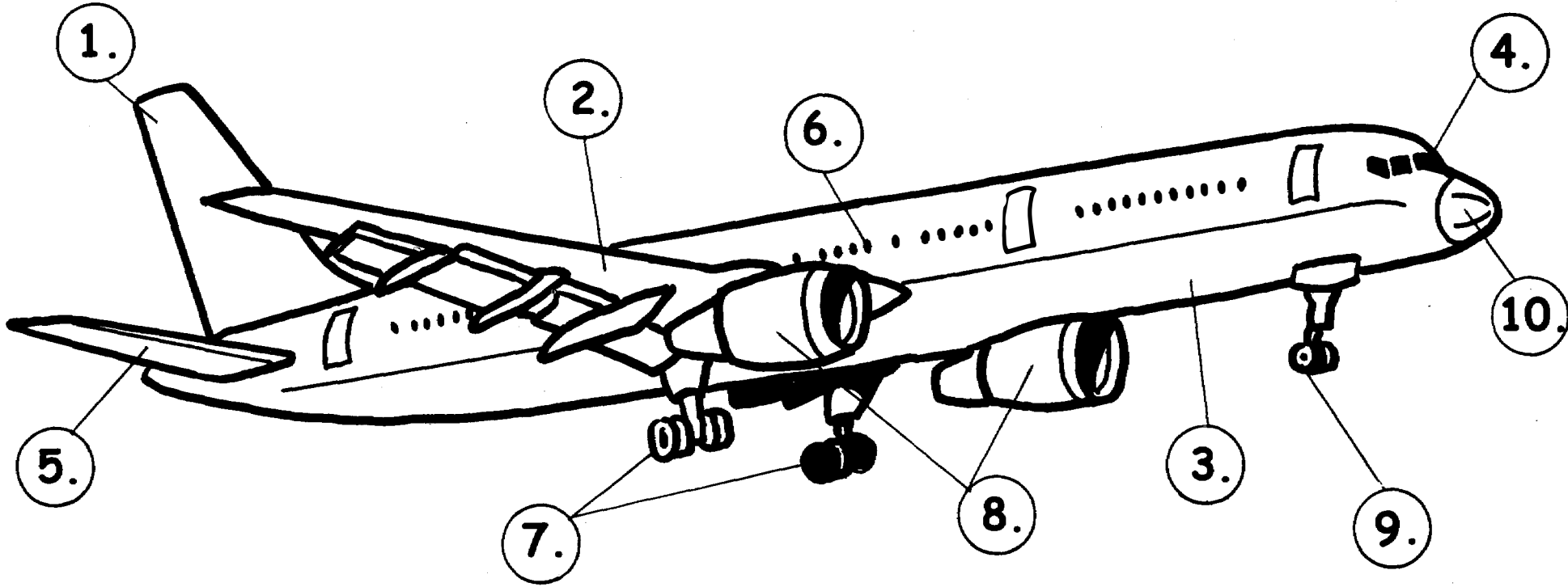

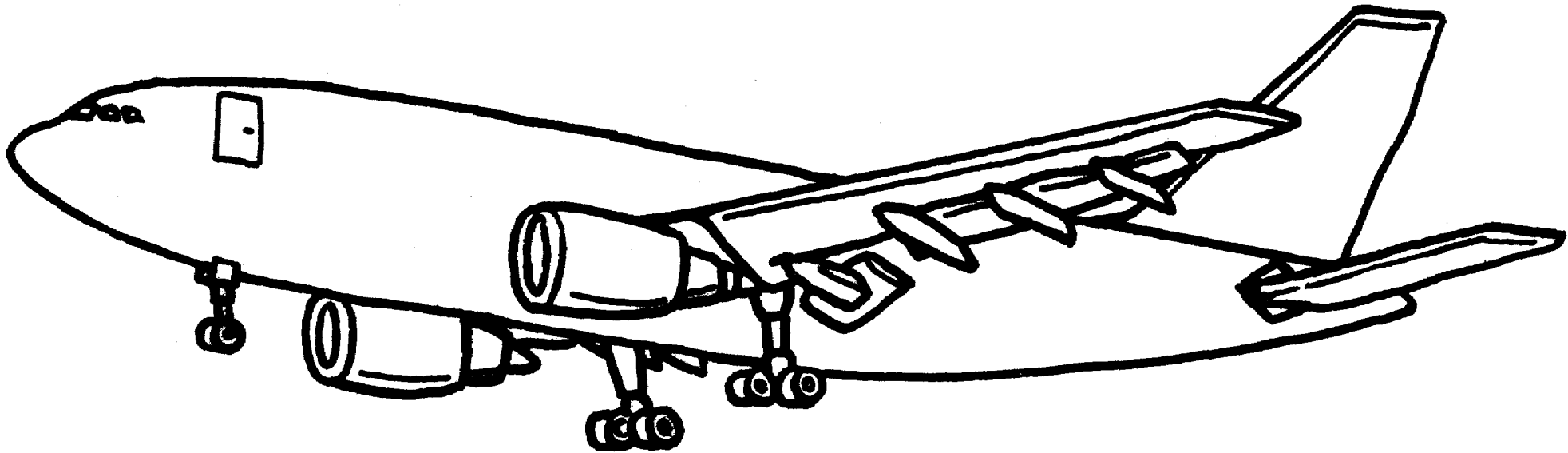

Every airline paints their planes differently.  
If you owned an airline, what would your airplanes look like?

# Eddie Martin

"Eddie Martin Airport" was founded in 1923. Years later it became known as Orange County Airport. It was named John Wayne Airport in 1979 by the Orange County Board of Supervisors.



EDDIE MARTIN

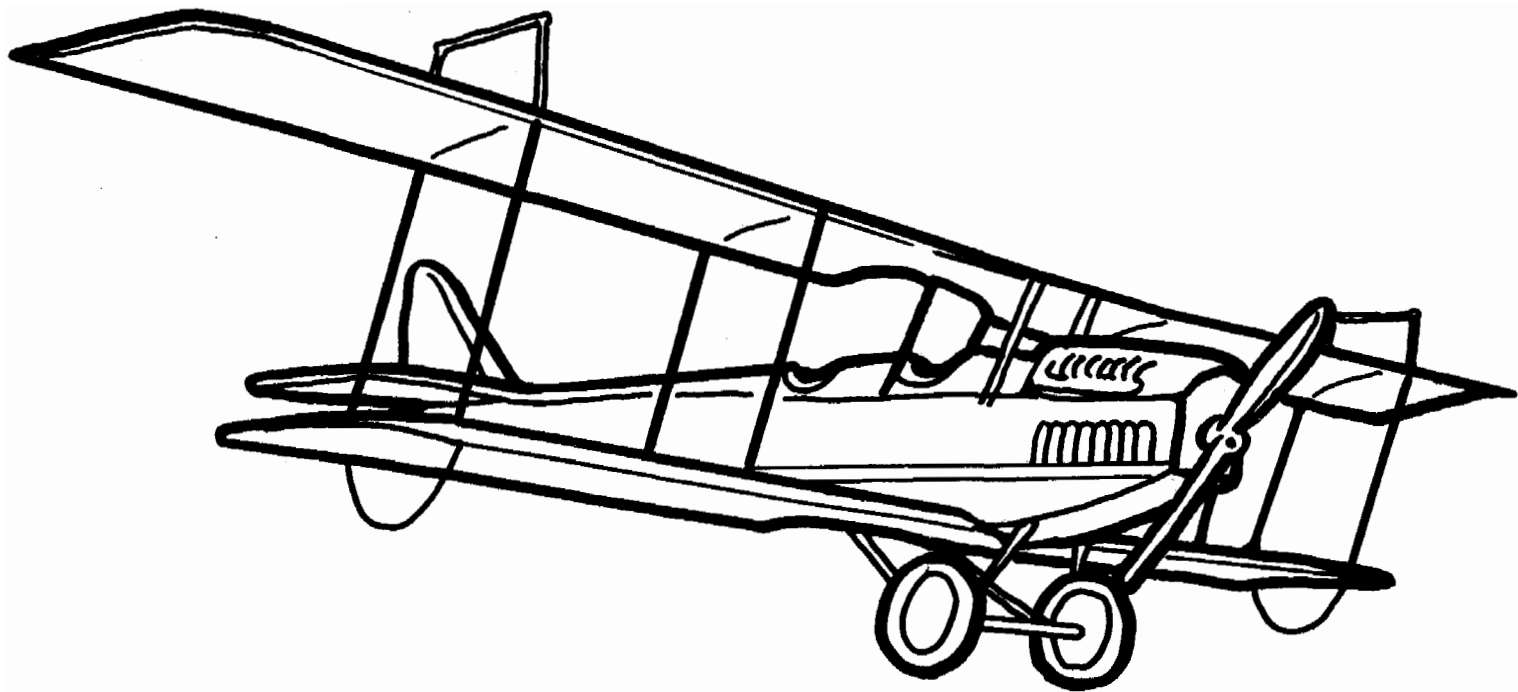

EDDIE MARTIN'S 1<sup>ST</sup> AIRPLANE WAS A "JENNY"

Each alphabet letter has a name pilots and control towers use to be sure they understand each other when they communicate by radio. See if you can spell your name using the Pilot's Alphabet.

# PILOT'S ALPHABET!

A ALPHA B BRAVO CHARLIE

D DELTA E ECHO F FOXTROT G GOLF H HOTEL

I INDIA J JULIET K KILO L LIMA

M MIKE N NOVEMBER O OSCAR

P PAPA Q QUEBEC R ROMEO

S SIERRA T TANGO U UNIFORM V VICTOR

W WHISKEY X X-RAY Y YANKEE Z ZULU

# ENTER THE JWA WEB SITE ART CONTEST

---

Draw and color an airplane  
and submit it to JWA.

Each month  
one drawing will be posted on the  
JWA Web site  
for all the world to see.

---

## Be creative and have fun!!!



Include the artist's first name, last initial and age on back of artwork

**SEND TO:**

JWA WEB SITE ART CONTEST - 18601 AIRPORT WAY - SANTA ANA, CA 92707

# **DRAW AND COLOR YOUR OWN AIRPLANE**

**Send your artwork to: JWA WEB SITE ART CONTEST - 18601 AIRPORT WAY - SANTA ANA, CA 92707**

Illustrations by Lynn Kubasek



2009

